

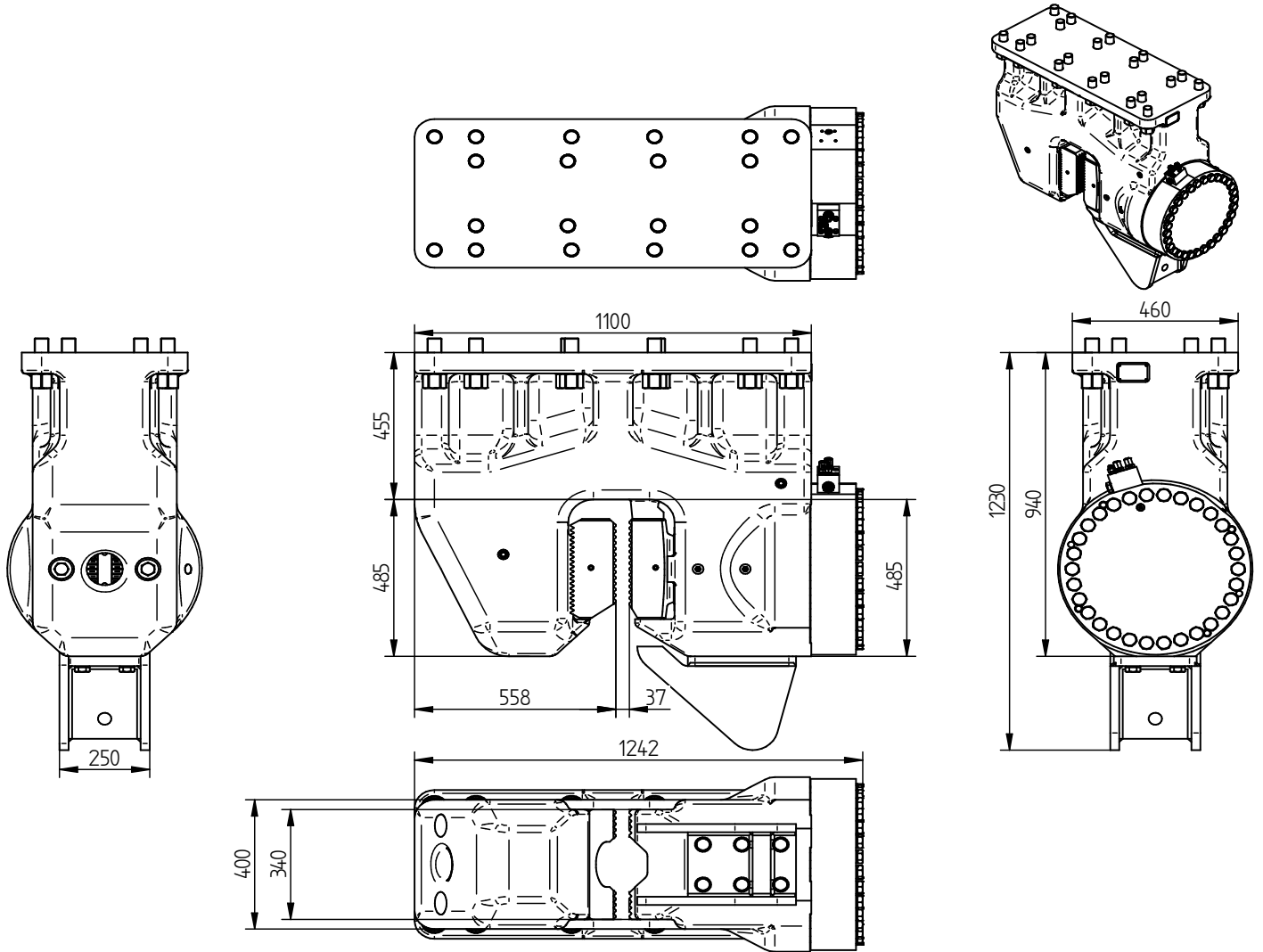

Specification sheet

PVE 350TU

Sheet Pile Clamp



Specifications :

PVE 350TU

Sheet pile clamp		
Clamping force	3500	kN
Max. operating press.	320	bar
Max. clamp open press.	120	bar
Weight	2600	kg

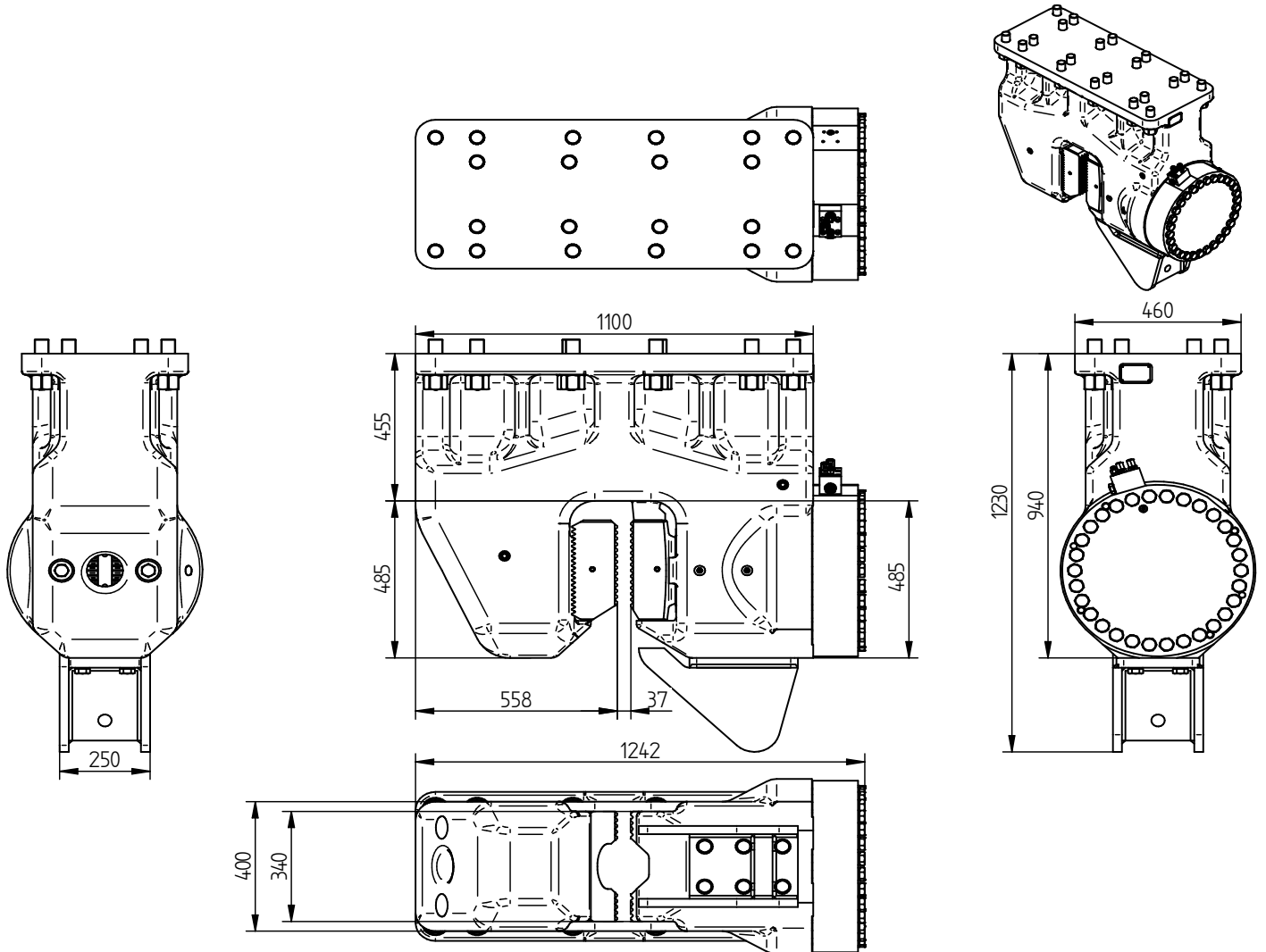

Technische Daten :

PVE 350TU

Spundwandzange		
Klemmkraft	3500	kN
Max. Betriebsdruck	320	bar
Max. Druck Zange Offen	120	bar
Gewicht	2600	kg



Spécifications

PVE 350TU

Pince palplanches

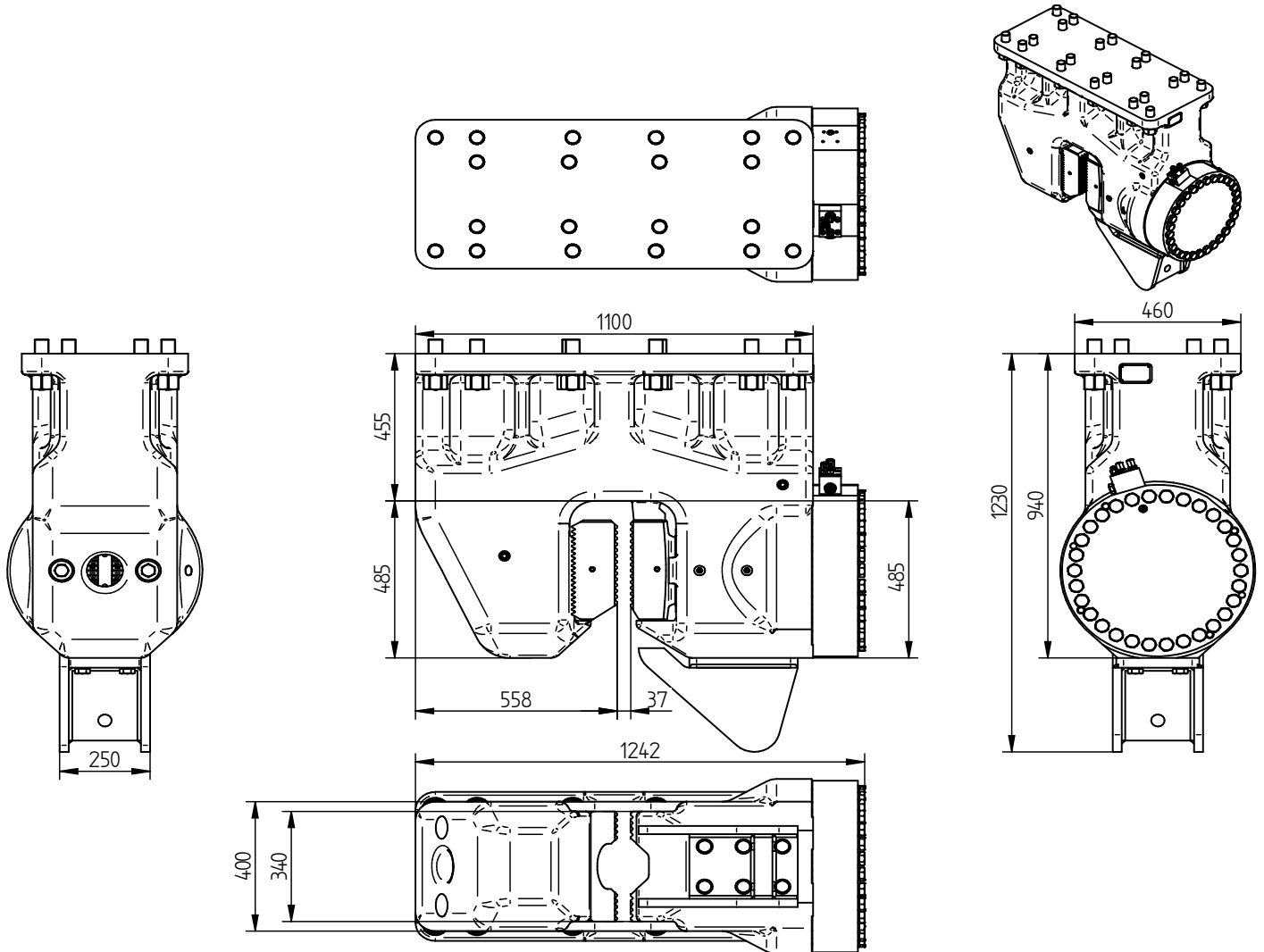

Spécifications

PVE 350TU

Pince palplanches		
Force de serrage	3500	kN
Pression de travail max.	320	bar
Pression pince ouvert max.	120	bar
Poids	2600	kg



Specificaties

PVE 350TU

Damwandklem

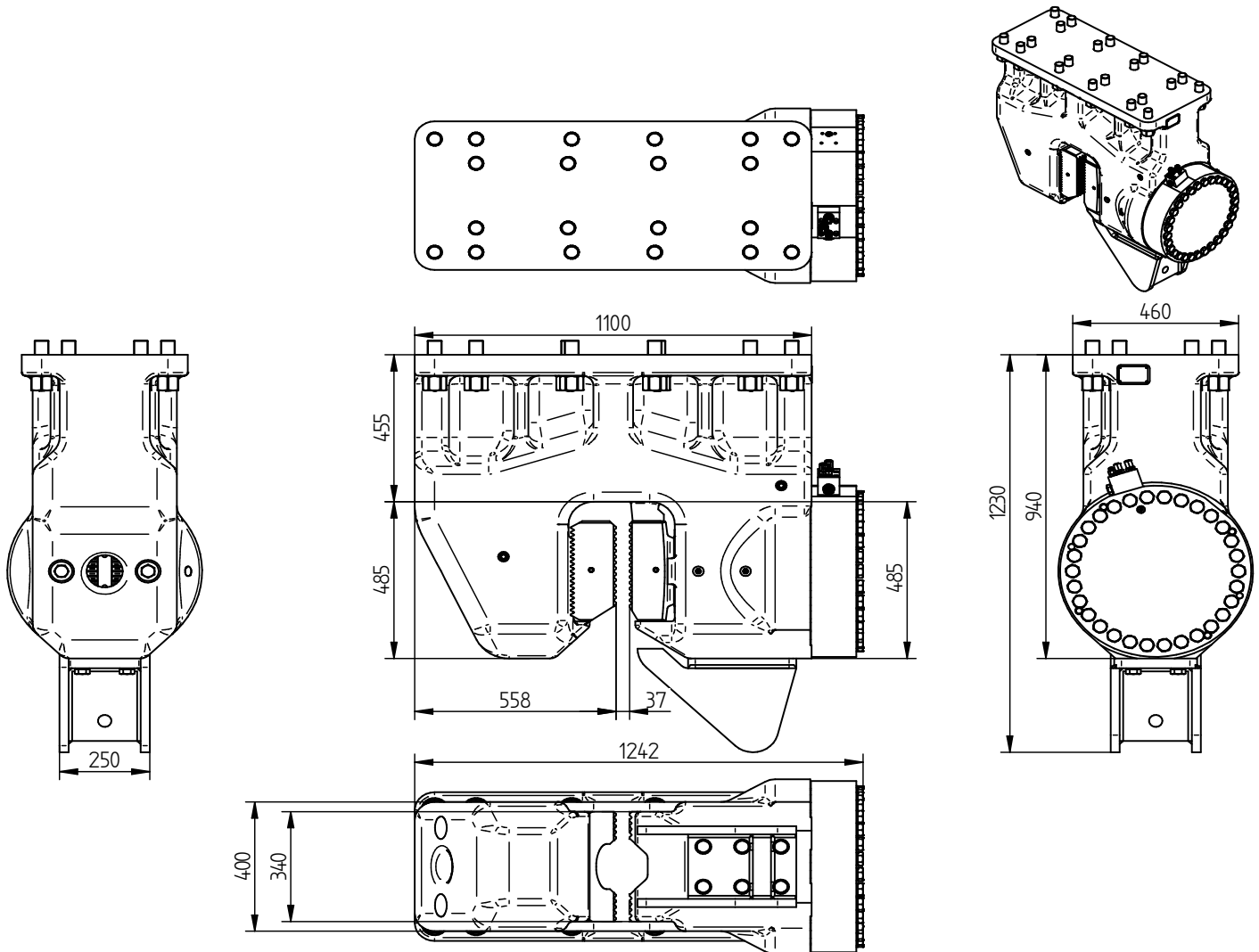

Specificaties

PVE 350TU

Damwandklem		
Klemkracht	3500	kN
Max. werkdruk	320	bar
Max. klem open druk	120	bar
Gewicht	2600	kg



Specificatii

PVE 350TU

Menghina pentru palplanse

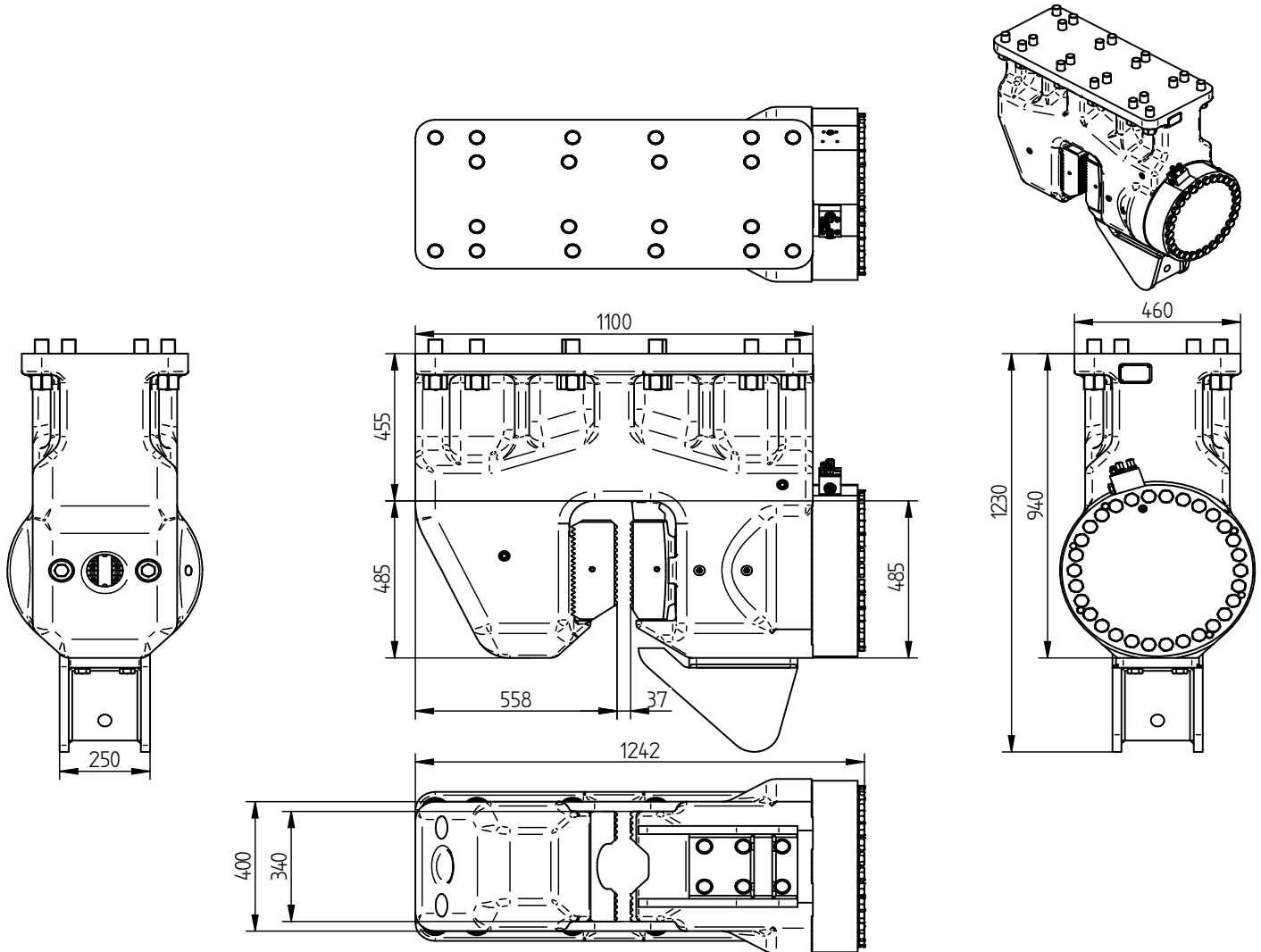

Specificatii

PVE 350TU

Menghina pentru palplanse		
Putere de strangere	3500	kN
Presiunea maxima de lucru	320	bar
Presiunea maxima cu menghina deschisa	120	bar
Greutate	2600	kg



Specifications

PVE 350TU

Sheet pile clamp

USA

INCHES

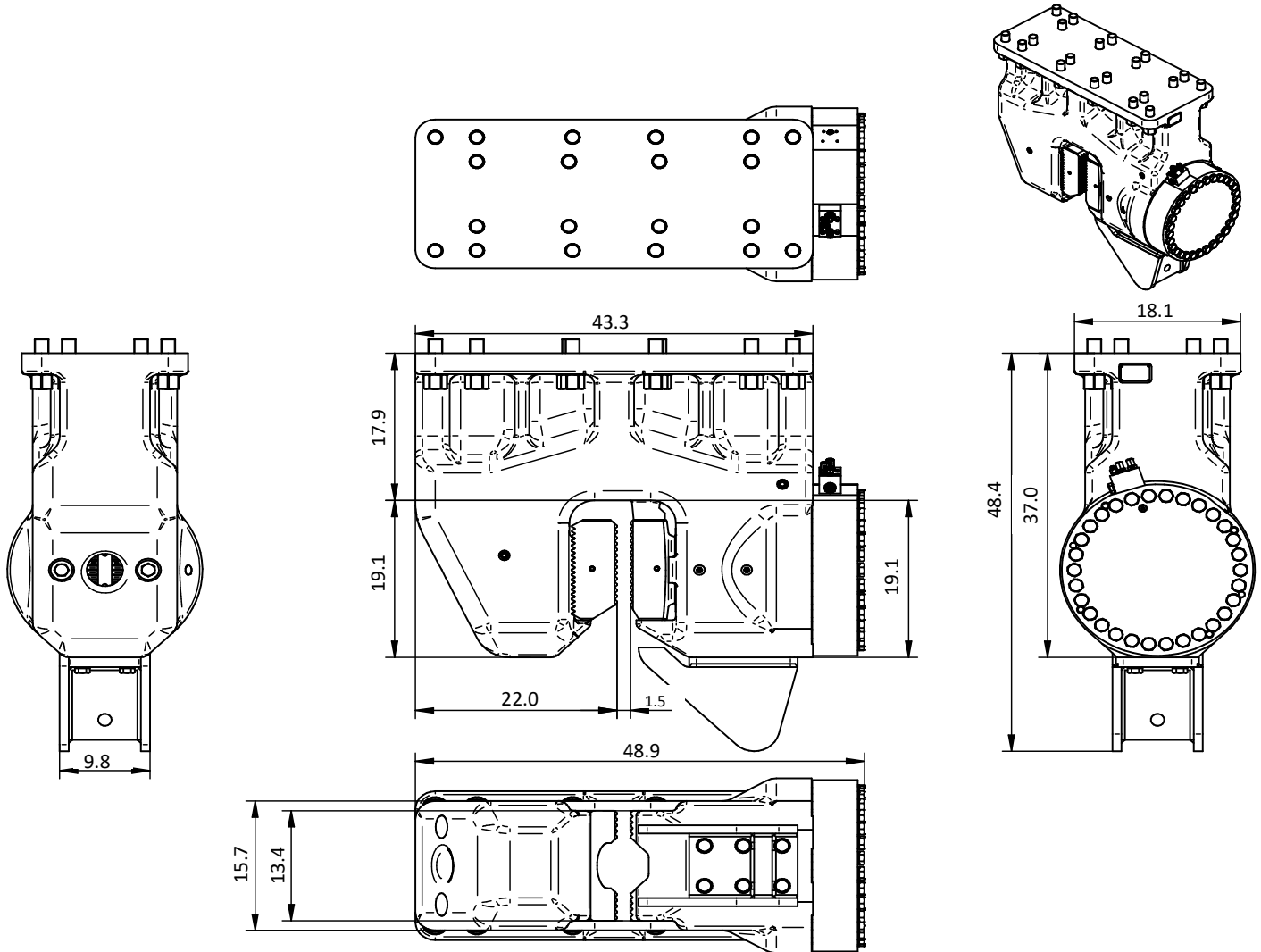

Specifications

PVE 350TU

Sheet pile clamp		
Clamping force	393	ton
Max. operating press.	4,641	psi
Max. clamp open press.	1,740	psi
Weight	5,732	lbs