

Specifications :

ICE 800 STAGE V / TIER 4F

Diesel Engine	CAT C18	
Max. theoretical power	563/755	kW/HP
Max. frequency	1800	rpm
Max. operating pressure	350	bar
Hydraulic pump	Rexroth	
Max. oil flow	810	L/min
Diesel oil	755	L
DEF (AdBlue) capacity	N.A.	L
Hydraulic oil	1600	L
Weight without fuel	8060	kg
Weight filled up	8700	kg

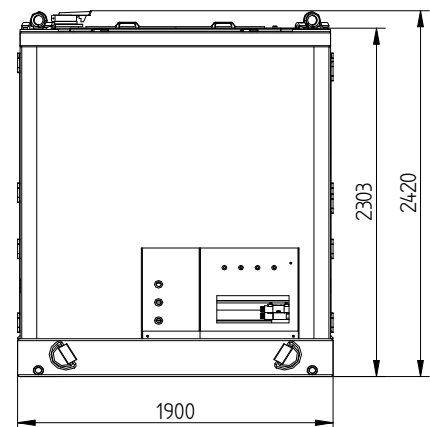
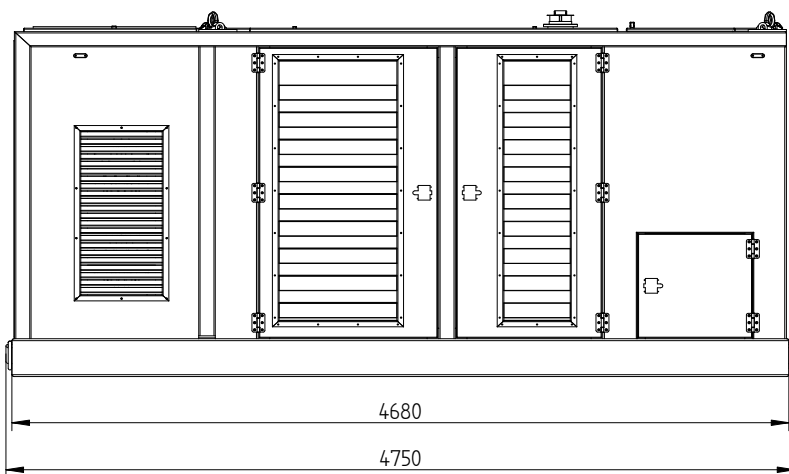
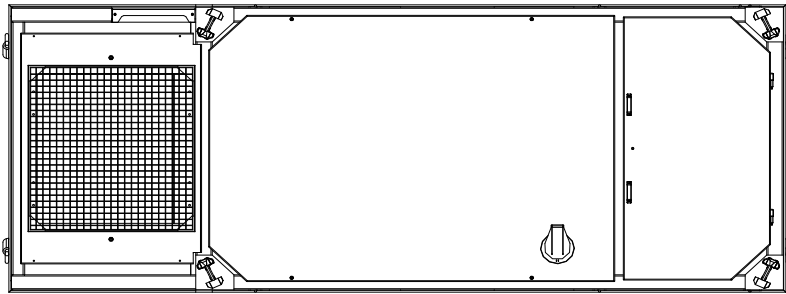

Technische Daten :

ICE 800 STAGE V / TIER 4F

Dieselmotor	CAT C18	
Max. theoretische Leistung	563/755	kW/HP
Max. Drehzahl	1800	rpm
Max. Betriebsdruck	350	bar
Hydraulische Pumpe	Rexroth	
Max. Fördermenge	810	L/min
Diesel Öl	755	L
DAF (AdBlue) kapazität	N.A.	L
Hydraulische Öl	1600	L
Gewicht ohne Diesel Öl	8060	kg
Gewicht	8700	kg

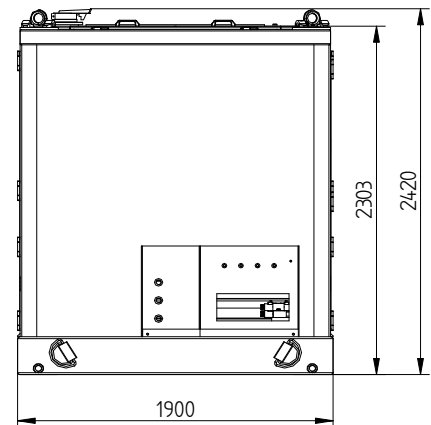
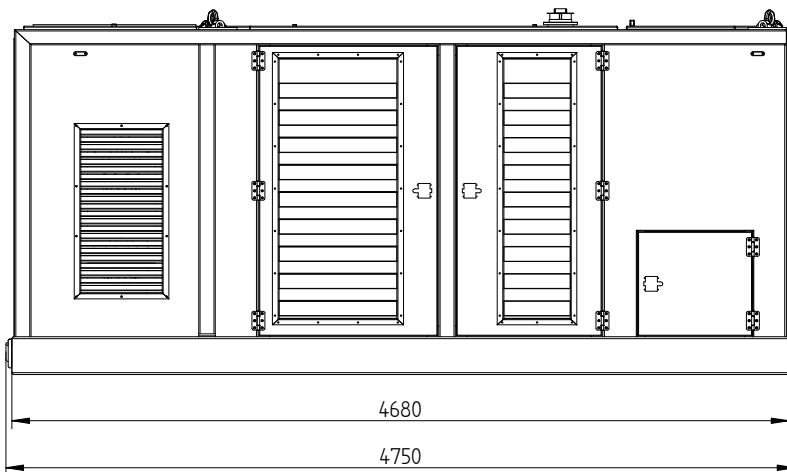
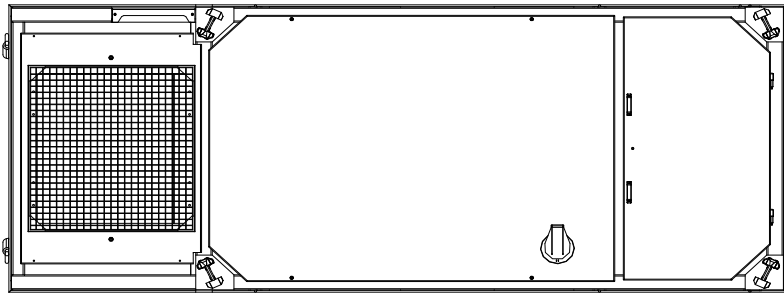

Spécifications

ICE 800 STAGE V / TIER 4F

Moteur Diesel	CAT C18	
Puissance théorique max.	563/755	kW/HP
Max. fréquence	1800	rpm
Pression de travail max.	350	bar
Pompe hydraulique	Rexroth	
Débit d'huile max.	810	L/min
Huile diesel	755	L
Capacité FED (AdBlue)	N.A.	L
Huile hydraulique	1600	L
Poids sans huile diesel	8060	kg
Poids	8700	kg

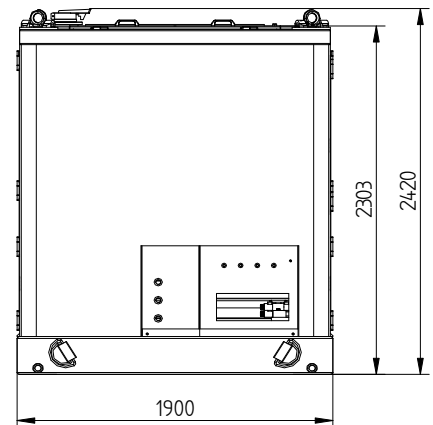
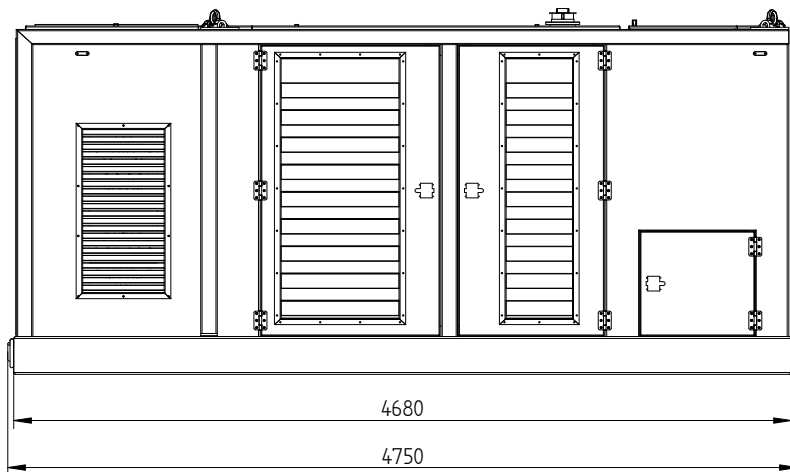
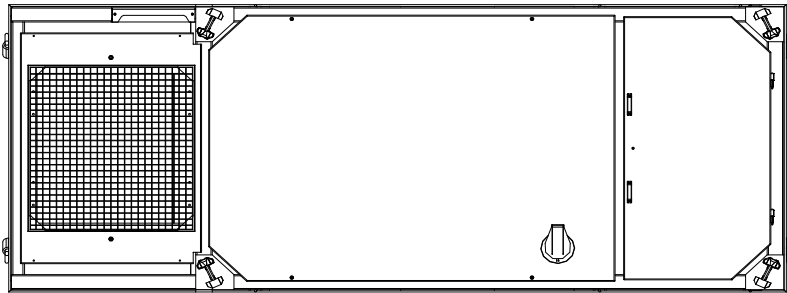

Specificaties

ICE 800 STAGE V / TIER 4F

Dieselmotor	CAT C18	
Max. theoretisch vermogen	563/755	kW/HP
Max. toerental	1800	rpm
Max. werkdruk	350	bar
Hydraulische pomp	Rexroth	
Max. olie doorstroming	810	L/min
Diesel olie	755	L
DEF (AdBlue) capaciteit	N.A.	L
Hydraulische olie	1600	L
Gewicht zonder diesel	8060	kg
Gewicht	8700	kg

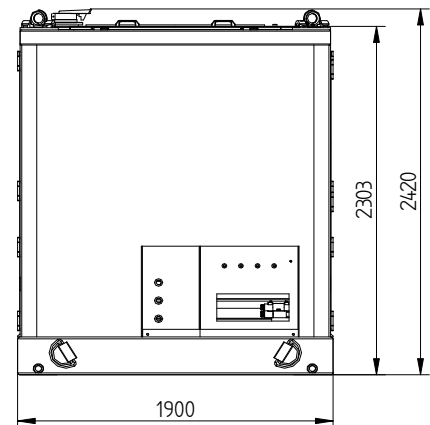
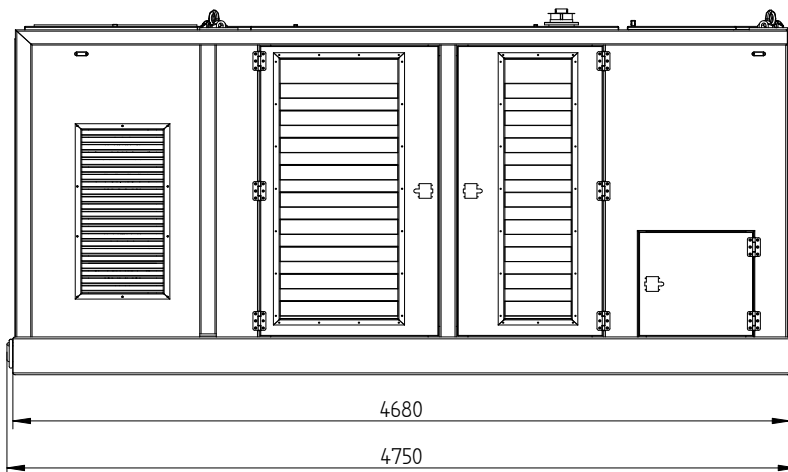
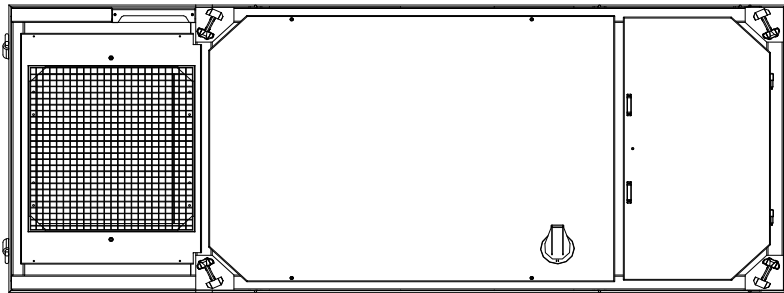

Especificaciones

ICE 800 STAGE V / TIER 4F

Motor de diesel	CAT C18	
Potencia Máxima teórica	563/755	kW/HP
Frecuencia máxima	1800	rpm
Presión máxima de trabajo	350	bar
Bomba hidráulica	Rexroth	
Flujo de aceite máximo	810	L/min
Gasóleo	755	L
Capacidad DEF (AdBlue)	N.A.	L
El aceite hidráulico	1600	L
Peso sin gasóleo	8060	kg
Peso	8700	kg

Specifications

ICE 800 STAGE V / TIER 4F

Hydraulic Power Pack

USA

Dimensions in inches

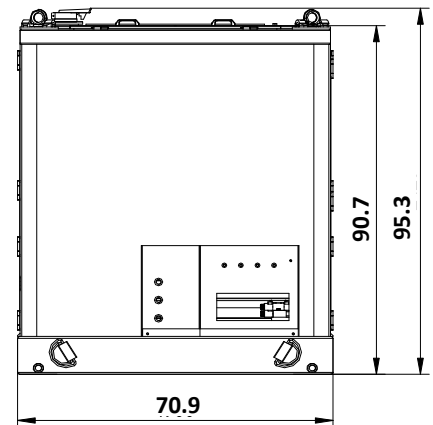
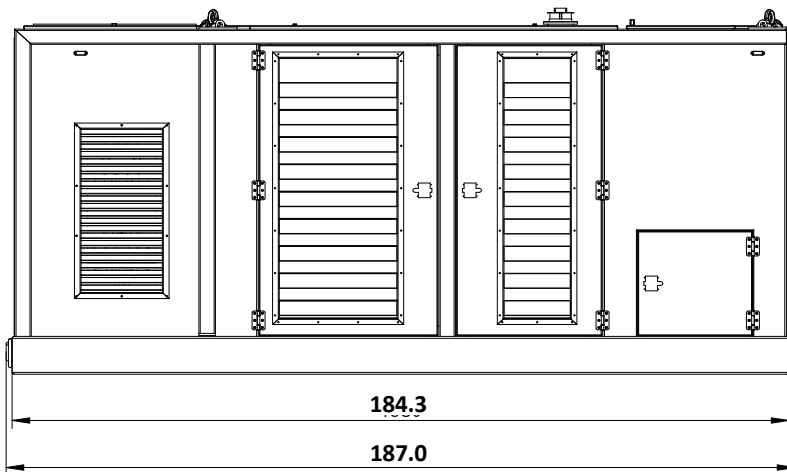
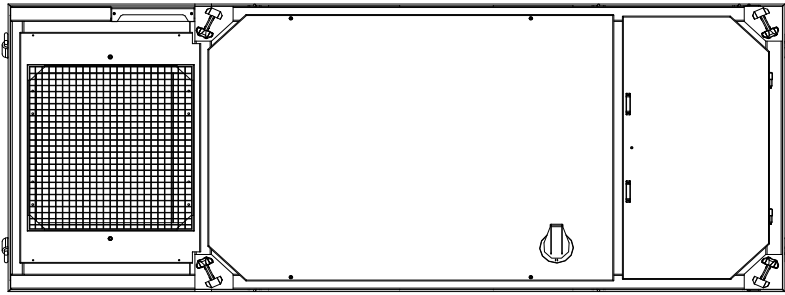

Specifications

ICE 800 STAGE V / TIER 4F

Diesel Engine	CAT C18	
Max. theoretical power	563/755	kW/HP
Max. frequency	1,800	rpm
Max. operating pressure	5,076	psi
Hydraulic pump	Rexroth	
Max. oil flow	214	gal/min
Diesel Fuel	199	gal
DEF (AdBlue) capacity	N.A.	gal
Hydraulic oil	423	gal
Weight without fuel	17,769	lbs
Weight with fuel	19,180	lbs

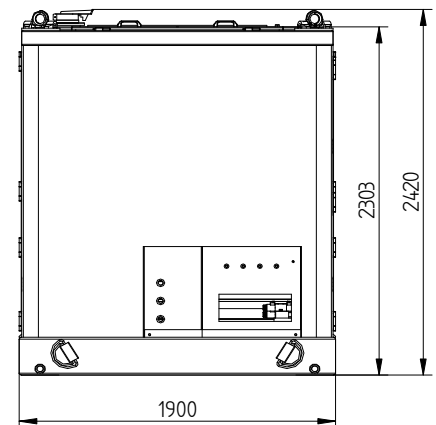
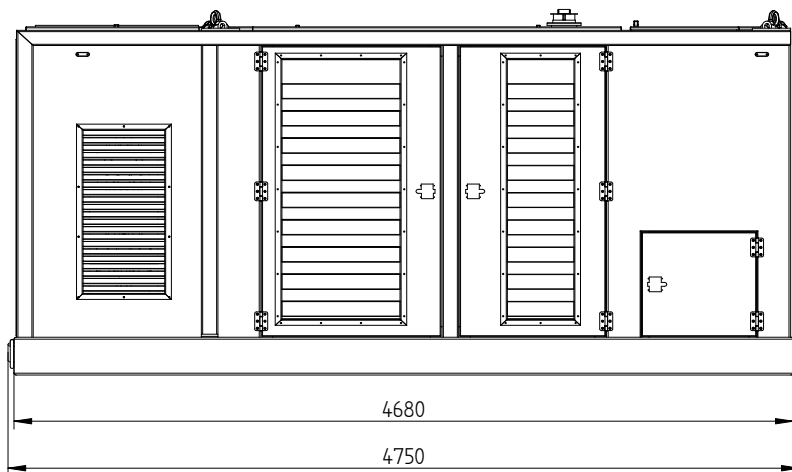
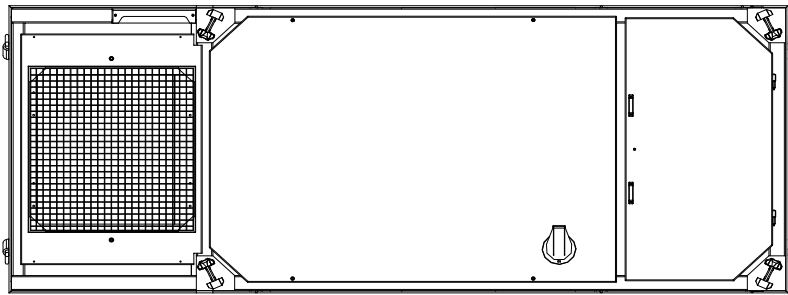

Specificatii :

ICE 800 STAGE V / TIER 4F

Motor diesel	CAT C18	
Puterea maxima teoretica	563/755	kW/HP
Frecventa maxima	1800	rpm
Presiune maxima de lucru	350	bar
Pompa hidraulica	Rexroth	
Debit maxim de ulei	810	L/min
motorină	755	L
Capacitate rezervor aditiv AdBlue	N.A.	L
Ulei hidraulic	1600	L
Greutatea fara combustibil	8060	kg
Greutatea cu combustibil	8700	kg